

STAVITELNÉ DRŽÁKY - ISO S
NASTAVITELNÉ DRŽIAKY - ISO S

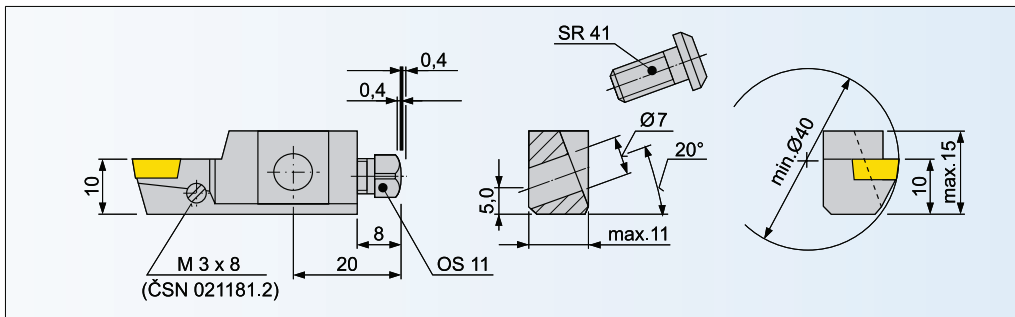

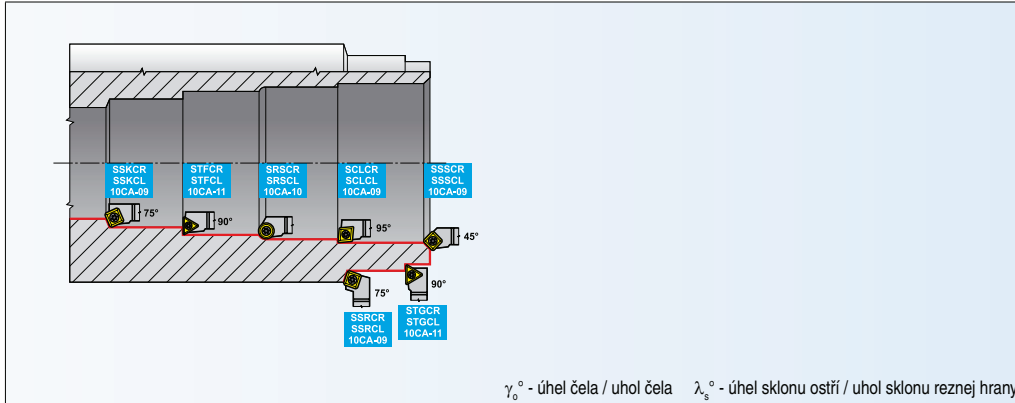

STAVITELNÉ DRŽÁKY / NASTAVITELNÉ DRŽIAKY

ISO	R/L	kg	náhradní díly náhradné diely	VBD VRD
SCLCR/L 10 CA-09	● / ○	0,06	SO4	CC.. 09T3.. 📄 145-147
SRSCR/L 10 CA-10	○ / ○	0,06	SO4	RC.. 10T3MO 📄 161-164
SSKCR/L 10 CA-09	● / ○	0,06	SO4	SC.. 09T3.. 📄 166-168
SSSCR/L 10 CA-09	○ / ○	0,06	SO4	SC.. 09T3.. 📄 166-168
SSRCR/L 10 CA-09	○ / ○	0,06	SO4	SC.. 09T3.. 📄 166-168
STFCL/L 10 CA-11	● / ○	0,06	SO1	TC.. 1102.. ⚠️ 📄 175-177
STGCR/L 10 CA-11	○ / ○	0,06	SO1	TC.. 1102.. ⚠️ 📄 175-177

NÁHRADNÍ DÍLY / NÁHRADNÉ DIELY

*) Utahovací momenty viz strana 336-337 / Utahovací momenty viz strana 336-337

Typ	Up. šroub* Up. skrutka*	Závít Závít	Podložka Podložka	Mezišroub Medziskrutka	Šroubovák Skrutkovač	Klíč Kľúč
SO1	US 2506-T07P 	(M2,5x6,3)	-	-	FLAG T07P 	-
SO4	US 3508-T15P	(M3,5x8,5)	-	-	FLAG T15P	-

● skladovaný ○ neskladovaný

Aktuální sortiment je dán platným ceníkem. / Aktuálny sortiment je daný platným ceníkom.

všechny rozměry v / všetky rozmery v [mm]

STAVITELNÉ DRŽÁKY - ISO S
 NASTAVITELNÉ DRŽIAKY - ISO S

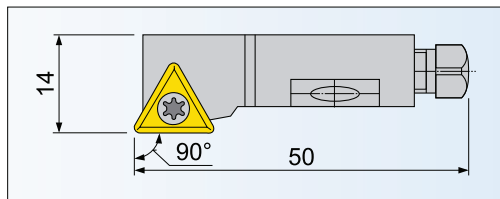
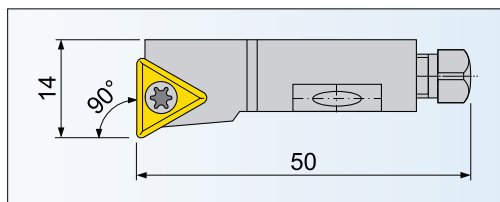
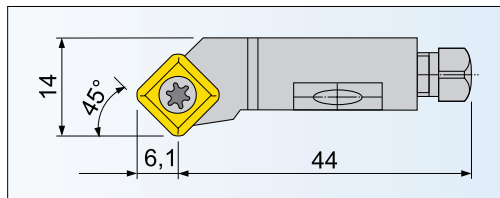
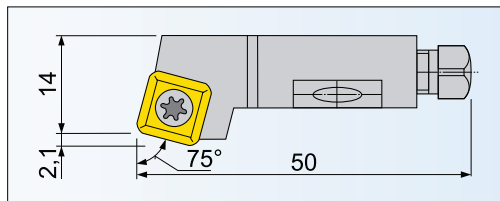
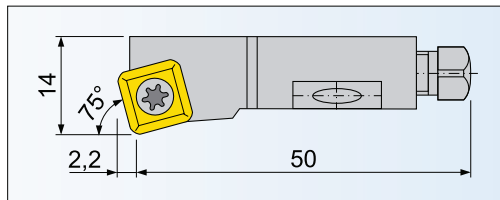
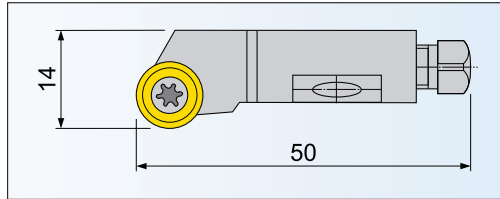
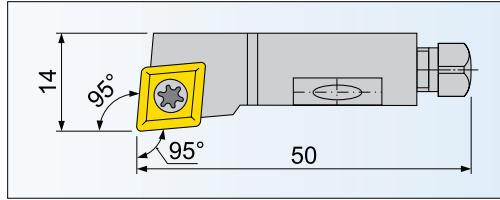

ISO C	ISO C
ISO D	ISO D
ISO M	ISO M
ISO P	ISO P
ISO S	ISO S
ZÁPICHY	ZÁPICHY
ZÁVITY	ZÁVITY
VBD	VRD